

Uputstvo za montažu kvadratnih kabina

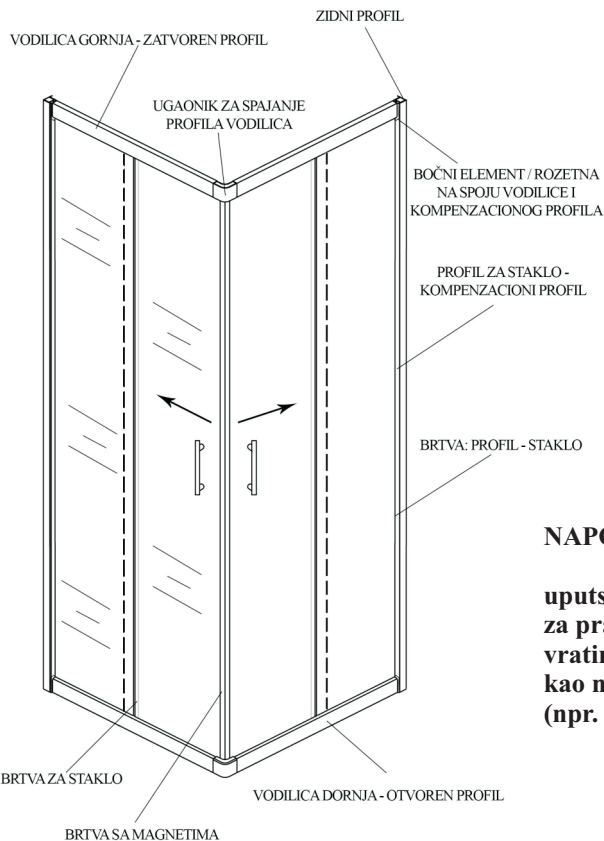

MODEL: DUAL

DIMENZIJE:

70x70 H183
80x80 H183
90x90 H183
100x100 H183

NAPOMENA:

uputstvo je adekvatno i za pravugaone kabine sa vratima pozicioniranim kao na glavnoj slici (npr. 110x70, 105x70,...)



Iako je kvalitet materija za kabine vrhunske kvalitete, može biti oštećen kako mehanički tako i upotrebom određenih hemikalija (ačeton i sl.). Takođe je moguće narušiti sjaj profila upotrebom abrazivnih sredstava.









U procesu ugradnje kabine preporučujemo da tuš, ako se na isti vrši montaža, zaštitite kartonom od mogućih oštećenja pri montaži kabine.

Proizvođač ne odgovara za štetu ili povredu osoba nastalih nepravilnom ugradnjom.

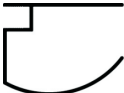



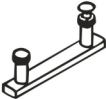





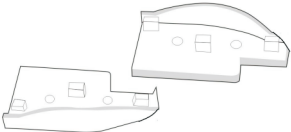

Brčko, BiH, tel. 049 590 470, fax. 049 590 473

POPIS ELEMENTA

OZNAKA	NAZIV ELEMENTA	IZGLED ELEMENTA	KOLIČINA
A	Vodilica gornja - zatvoren profil		2
B	Vodilica donja - otvoren profil		2
C	Profil za staklo - kompenzacioni profil		2
D	Zidni profil		2
E	Trackic gornji		4
F	Trackic donji		4
G	Rukohvat / Rucka		2
H	Brtva sa magnetima		1

POPIS ELEMENTA

OZNAKA	NAZIV ELEMENTA	IZGLED ELEMENTA	KOLIČINA
H	Brtva za staklo -visina 1,8 m		4
I	Brtva: profil - staklo		2
J	Bocni element - rozetna na spoju vodilice i vertikalnog profila		2 lijeva + 2 desna
K	Držac fiksnog stakla + Vijak 4,2x16, upuštena glava		4 + 4
L	Vijak 3,5x25/32 - za spajanje vodilica sa vertikalnim profi.		8
M	Vijak 4,2x13, samourezujući ravna glava		10
N	Vijak 5x35, za tipl		6
O	Vijak 4,2x9,5 mm, za stoper ravna glava		8
P	Tipl Ø8 mm, Fischer		6
R	Granicnik/Stoper, gumeni		8
S	Ugaonik, za spajanje profila vodilica		2

Slika 1. Nivelisanje tuš kade

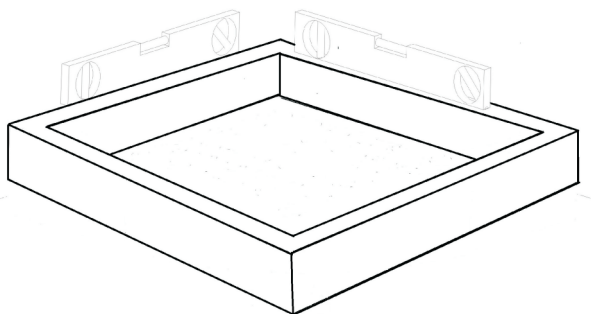

Slika 2. Nivelisanje zidnih profila

Libelom izvršiti nivelisanje zidnih profila

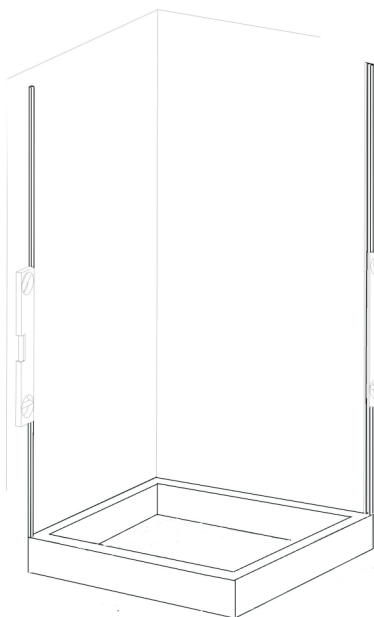

Slika 3. Učvršćivanje zidnih profila

Označite mjesto za bušenje na zidu.

Odmaknite profil, izbušite rupe i postavite tiplove. Nanesite silikon na zadnju stranu profila, postavite profil na zid i pričvrstite ga vijcima 5x35 mm.

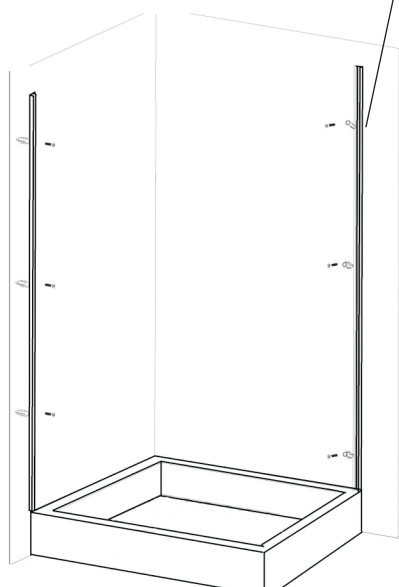
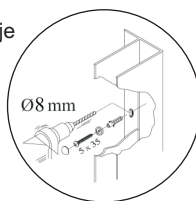

Slika 4. Montaža fiksnih stakala

Fiksiranje držača fiksnih stakala sa vijcima 4,2x16 upuštene glave

Spajanje gornjih vodiliča sa vertikalnim profilom pomoću vijaka 3,5x25/32

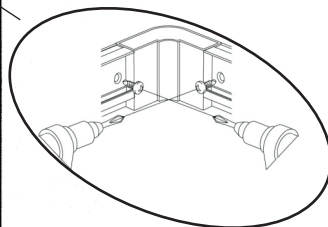
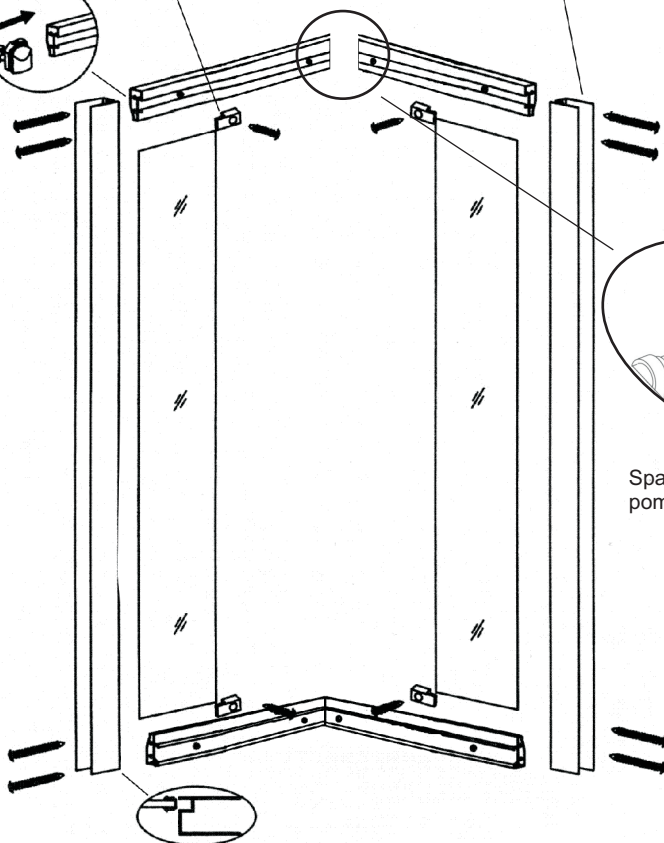
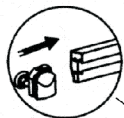
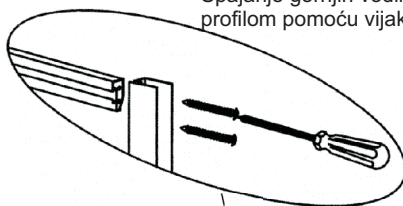
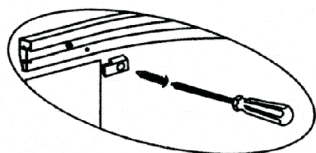

Spajanje ugaonika i vodiliča pomoću SU vijaka 4,2x13

Slika 5. Spajanje zidnih i kompenzacionih profila

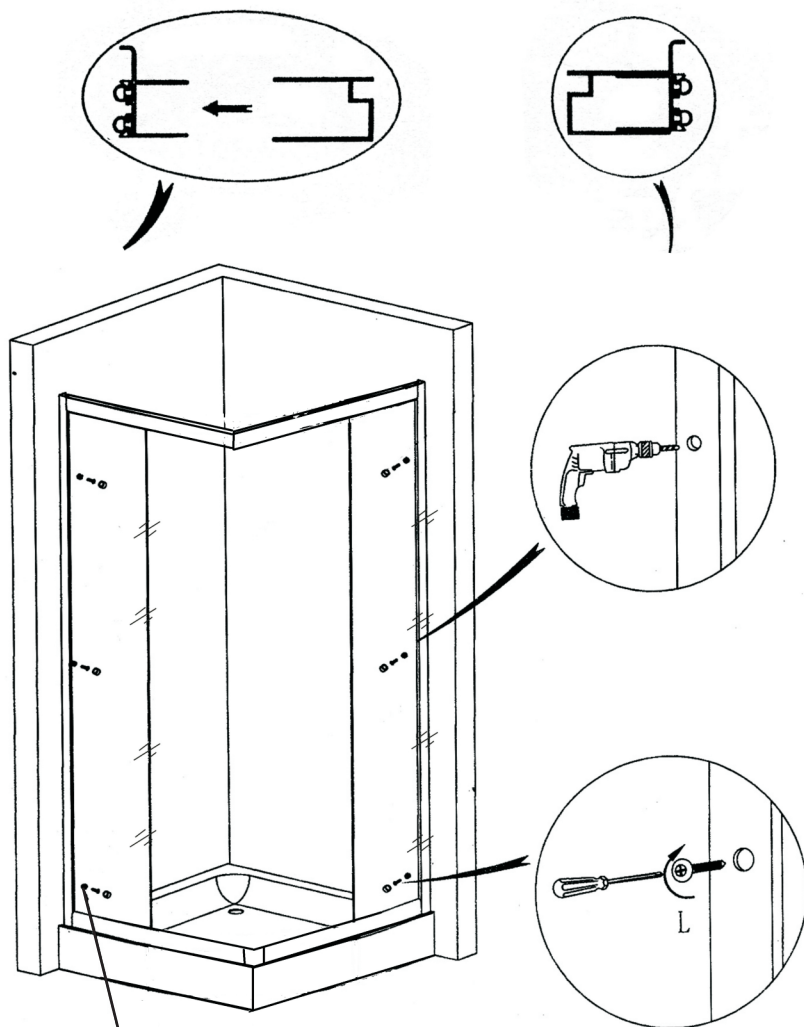

Spajanje zidnog i kompenzacionog profila izvodi se vijcima 4,2x13, samourezujuci ravna glava

Slika 6. Nivelaćija stakala na kabini

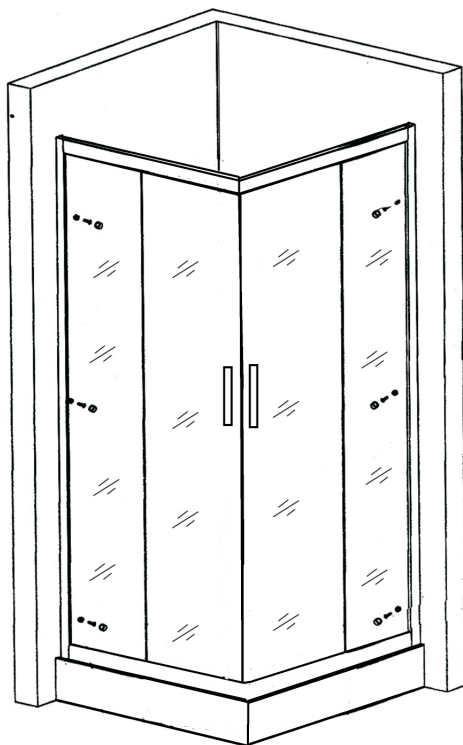
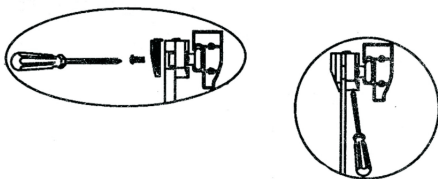

Na zakrivljena stakla se montiraju točkići i staklo se postavlja na odgovarajuće profile kao što je prikazano na slici

Slika 7. Postavljanje brtvi na stakla



Između profila i stakla ubačuje se brtva. Zbog lakšeg ubačivanja brtve potrebno je istu rastezati pri ugradnji, obzirom da je od silikona.

